



S.P.A.M. WEEKLY

Week 3: 1/20/25 - 1/26/25

Week Three

Keep an eye out for information about robot name voting this upcoming Saturday! the mechanical team has started building the chassis and programming is diving into some neat vision processing and path planning code!

Did you know that national orange chicken day is celebrated on July 15th every year?



-Zachary Dean, President



Mechanical

Progress:

- Semi-completed chasis
- 4/5 Swerve modules built
- Successful Algae grabber prototype

Next Week's Goals:

- Build elevator
- Build cage climb
- Start end-effector build

CAD

Progress:

- Elevator finalized
- Deep climb finalized
- Base chasis finalized

Next Week's Goals:

- Layout electrical components
- Investigating coral intake

Programming

Progress:

- Simulated reef alignment/tracking code
- tested on-the-fly path generation in Pathplanner
- Started simulating automatic scoring sequence

Next Week's Goals:

- Obtain mechanism information from CAD for physics simulation
- Continue vision

Awards

Progress:

- Woodie Flowers
- Impact Essay
- Executive Summary
- Begun Impact Video Planning

Next Week's Goals:

- Continue essays & video

Field Building

Progress:

- Built Barge Structure
- Built Processor
- Built Human Coral Station

Next Week's Goals:

- Finish Barge
- Start second half of field

Fundraising & Outreach

Progress:

- Zoom call with team 7611 Amal Hawks Robotics

Next Week's Goals:

- Continue reaching out to sponsors!!



S.P.A.M. needs your help fundraising!



We are in need of sponsors to help cover our travel & robot costs! Talk to a mentor at the admin table if you need help reaching out. We have email templates and a big list of sponsors to help you get started.

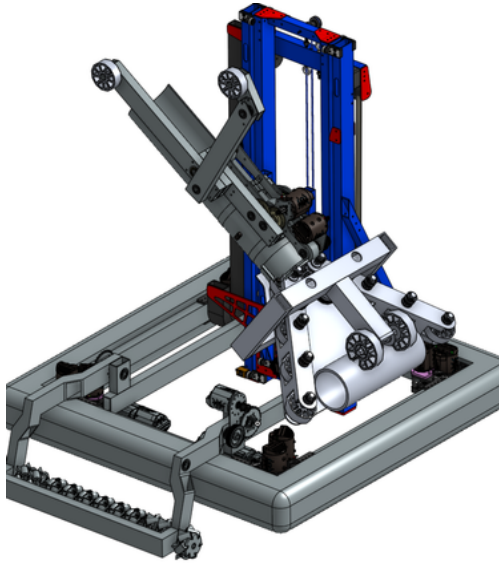
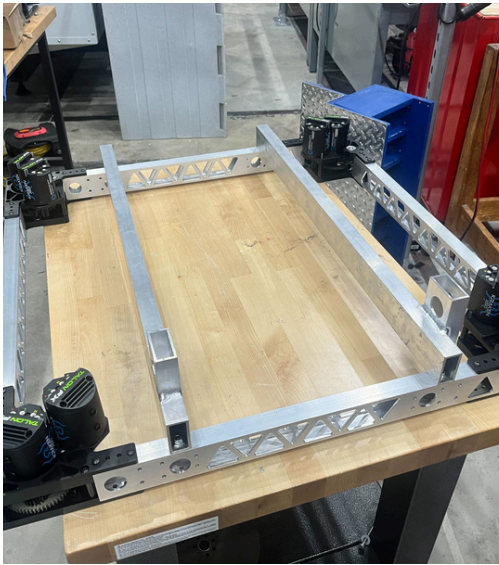
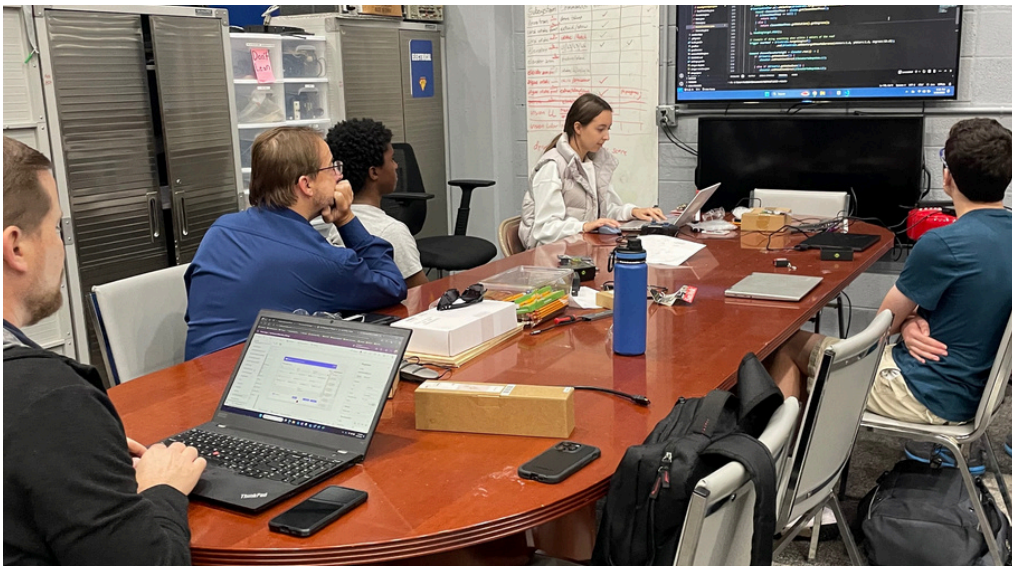

20

February Meetings

25

Sun

Mon

Tues

Wed

Thurs

Fri

Sat

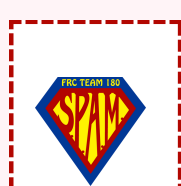
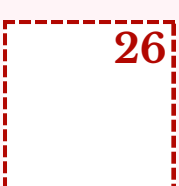
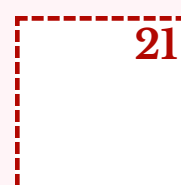
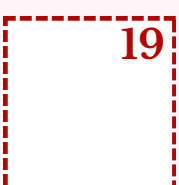
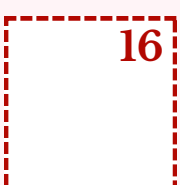
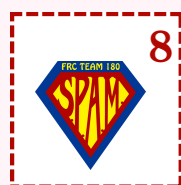
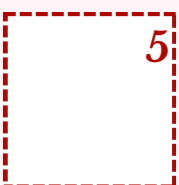
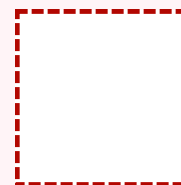
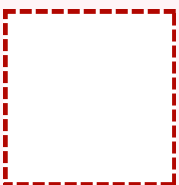
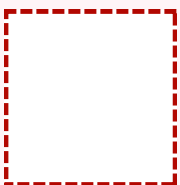

Our Schedule is also on our [website](#)!!

THANK YOU

Made by Zach & Isabella